

LTW15

Thank you for having chosen a LAE electronic product. Before installing the instrument, please read these instructions carefully to ensure maximum performance and safety.

1. INSTALLATION

1.1. LTW15 is sized 77x35x77 mm (WxHxD). It is inserted into the panel through a hole 71x29 mm and secured by pressing gently into the relative clamps. The rubber gasket should be placed between the instrument frame and the panel, checking its seal to avoid infiltration.

1.2. The instrument should operate at an ambient temperature between -10°...+50°C and relative humidity between 15%...80%. To reduce the effects of electromagnetic disturbance, ensure that the sensor and signal cables are well separated from the power conductors.

1.3. The supply voltage, switched powers and arrangement of connections must be in compliance with the indications given on the container. If there is a sensor shield, it must be earthed through the metal structure. The instrument should be powered with the special transformer mod. TRxxx.

CAUTION: if the relays must frequently change over a heavy load, it is advisable to contact the manufacturer to obtain indications regarding the lifetime of the contacts.

Whenever products are to be stored within very rigid specifications or they are very valuable, it is advisable to use a second instrument that can activate or warn in the event of any malfunction.

2. CONTROL PARAMETERS

The regulator is adapted to the controlled system by suitably programming its configuration parameters from the setup menu. The instrument comes with a general setup and cannot therefore be used without having first checked that the parameters are correct. Setup is accessed by pressing in succession the keys \leftarrow + SET + \rightarrow and keeping them pressed simultaneously for 3 seconds. The available parameters appear in TABLE 1 shown below.

Use the keys \rightarrow / \leftarrow to pass from one parameter to the next/previous one. To display the correlated value, press the key SET , to change it, press SET + \rightarrow or \leftarrow simultaneously. Press the key ESC to exit from setup; if the keyboard is not touched for 30 seconds, exit is automatic. The set point **1SP**, associated with output 1, may also be displayed and adjusted during normal regulator operation by pressing the key SET + \rightarrow or \leftarrow . If the lock of key ESC is deactivated (**LOC=Off**), the set point/differential **2SP/2DF**, associated with output 2, may also be displayed and adjusted during normal regulator operation by pressing the key ESC + \rightarrow or \leftarrow . Both set points in any case remain within the limits **SPL** and **SPH**.

SCL	CO.1/CO1/FO1	Reading scale	2SP	SPL...SPH [°]	Effective temperature set point channel 2
*INP	0mA/4mA	Minimum current provided by transmitter	2DF	-150...150 [°]	Temp. differential set 2 to set 1
*RLO	-199...RHI	Minimum range value	2OM	FRE/BND	Mode of operation output channels
*RHI	RLO...999	Maximum range value	2Y	HY/PID/ALR	Control type channel 2
SPL	-199...SPH[°]	Minimum temperature set point	2HY	-199...199 [°]	Changeover hysteresis channel 2
SPH	SPL...999[°]	Maximum temperature set point	2PB	-199...199 [°]	Proportional band channel 2
1SP	SPL...SPH [°]	Effective temperature set point channel 1	2IT	0...999 [s]	Integral action time channel 2
1Y	HY/PID	Control type channel 1	2DT	0...999 [s]	Derivative action time channel 2
1HY	-199...199 [°]	Change-over hysteresis channel 1	2AR	0...100%	Reset of integral action referred to Pb2
1PB	-199...199 [°]	Proportional band channel 1	2CT	0...255 [s]	Cycle time channel 2
1IT	0...999 [s]	Integral action time channel 1	2PF	ON/OFF	Channel 2 status with faulty sensor
1DT	0...999 [s]	Derivative action time channel 1	LOC	YES/NO	Lock of key ESC
1AR	0...100%	Reset of integral action referred to Pb1	SIM	0...100	Display slowdown
1CT	0...255 [s]	Cycle time channel 1	OS1	-150...150[°]	Sensor correction
1PF	ON/OFF	Channel 1 status with faulty sensor	ADR	0...255	Peripheral address
2CM	ABS/REL	Control mode channel 2			

TABLE 1

*Note: LTW15I... (input 0/4÷20mA) only.

3. DISPLAYS

For approx. three seconds upon switching on, the instrument displays --- (internal self-test phase). Subsequent indications depend on the operating status of the regulator. TABLE 2 gives the indications associated with the various states.

The temperature measured by the sensor is processed by the microprocessor to display it in the most representative way. For this

purpose it may be corrected with a fixed offset, assigning the parameter OS1 a value other than zero, and displayed in the desired scale by setting the parameter **SCL**: with **SCL=C0.1** the temperature is displayed with a resolution of one tenth of a degree in the range -19.9...99.9°C; with **SCL=C01** or **F01** the temperature is displayed with a resolution of a degree in the Celsius or Fahrenheit scale respectively.

Prior to display, the temperature is processed by a special algorithm, which allows the simulation of a thermal mass directly proportional to the **SIM** value; the resulting effect is a reduction in the oscillation of the displayed value.
The status of the outputs is shown through the respective luminous points on the display.

LTW151 only: in order to get the value measured to be displayed in a correct way, you must get the parameters of the controller to match the transmitter fitted. With **INP** you program the minimum current the transmitter provides, according to the scales 0÷20mA, 4÷20mA. To **RLO** you must set the minimum value that the transmitter can measure (matching the minimum current 0/4mA); to **RHI** you must set the maximum value measured (matching the maximum current 20mA). With **SCL=0.1** you enable decimal point readout. The measured value can be corrected with a fixed offset, assigning the parameter **OS1** a value other than zero.

CAUTION: when changing the display scale SCL, the parameters related to the absolute (1SP, 2SP, 1Pb, 2Pb,...) and differential (1HY, 2HY, 2DF, ...) temperatures **MUST** be reconfigured.

---	Internal self-test (3 seconds)	E1	In tuning: timeout 1 error
5.4	Sensor T1 temperature	E2	In tuning: timeout 2 error
or	Over range or breakage T1	E3	In tuning: over range error
Tun / 5.4	Instrument in auto-tuning		

TABLE 2

4. CHANNEL 1 OPERATION

4.1. TYPE OF CONTROL. Channel 1 may operate in the ON/OFF or PID mode: **1Y=HY** is fixed for ON/OFF control, **1Y=PID** for PID control.

4.2. ON/OFF CONTROL. In the ON/OFF mode the output is ON or OFF in relation to the input temperature, set point (**1SP**) and hysteresis value (**1HY**). The hysteresis indicates the amplitude of deviation of the temperature from the set point in order to reactivate the output. Increasing the hysteresis value decreases the switchovers of the output, while decreasing the hysteresis value gives finer control. For channel 1 to operate in the heating mode, assign a negative value (see Figure 1) to **1HY**; assign a positive value for control in the cooling mode (see Figure 2). With **1HY=0** the output is permanently cut out. After a switchover the output remains in the new state for a minimum time of **1CT** seconds irrespective of the temperature value.

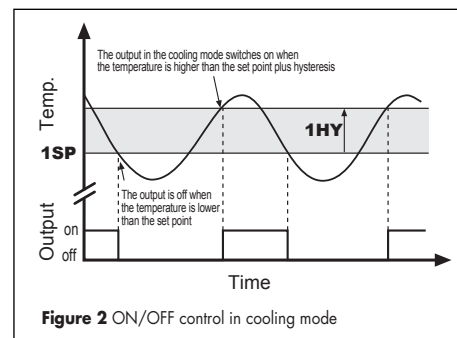
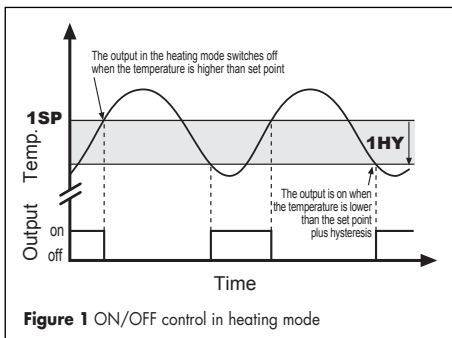

4.3. PID CONTROL. In the PID mode the output is ON for a fraction of the cycle time **1CT**. The cycle time characterises the dynamics of the system to be controlled and influences the accuracy of the control: the higher the system speed of response the shorter the cycle time to obtain greater temperature stability and less sensitivity to variations in load. Assign a negative value to **1PB** to make channel 1 operate in the heating mode (see Figure 3) and a positive value for control in the cooling mode. With **1PB=0** the output is permanently cut out.

4.3.1 PROPORTIONAL CONTROL. The temperature is controlled by varying the time of activation of channel 1 when the temperature is inside the proportional band (**1PB**). The nearer the temperature to set point, the less time of activation. A small proportional band increases the promptness of response of the system to temperature variations, but tends to make it less stable. A purely proportional control stabilises the temperature within the proportional band but does not cancel the deviation from the set point.

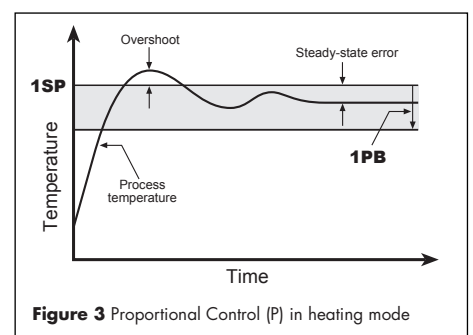

4.3.2. PROPORTIONAL-INTEGRAL CONTROL. The steady-state error is cancelled by inserting an integral action into the control system. The integral action time, **1IT**, determines the speed of cancellation of the error, but a high speed (**1IT** low) may be the cause of overshoot and instability in the response. The integral part normally acts within the proportional band, but this area of action may be reduced in terms of percentage by lowering the integral action reset **1AR**. The response overshoot is thus decreased. The integral control is cancelled when the temperature goes outside the area of action of the integral part. With **1IT=0** the integral control is disabled.

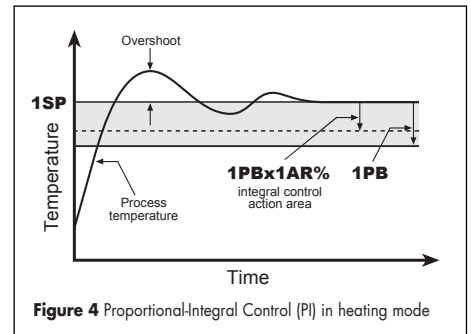

4.3.3. PROPORTIONAL-INTEGRAL-DERIVATIVE CONTROL. Response overshoot in a system controlled by a PI controller may be reduced by inserting a derivative action in the control. The derivative action is greater the faster the temperature variation within the time unit. A controller with a high derivative action (**1DT** high) is extremely sensitive to small temperature variations and can make the system unstable. With **1DT=0** the derivative control is disabled.

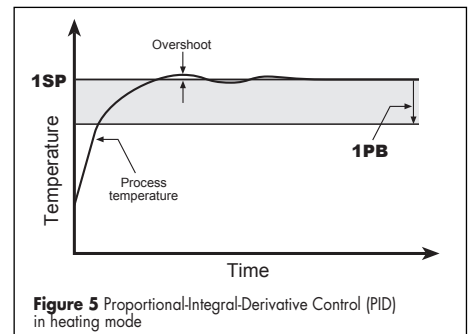

4.4. MALFUNCTIONING. Following a sensor malfunction,  appears on the display and the output is controlled according to the value of the parameter **1PF**.

CAUTION: when programming the hysteresis **1HY** or the proportional band **1PB**, it is advisable to consider the number of switchovers that the relay will carry out and, if necessary, adapt the cycle time in order to limit the frequency of switchever.

5. CHANNEL 2 OPERATION

5.1. CHANNEL 2 SET POINT. The channel 2 set point may be fixed in an absolute way (**2CM=ABS**), or a relative way in relation to set point 1 (**2CM=REL**). If **2CM=ABS** set point 2 is expressed with the parameter **2SP**; if **2CM=REL** set point 2 is expressed with the parameter **2DF**.

Example 1: **2CM=ABS**, **2SP=-12.5**: set point2 = $2SP = -12.5$.

Example 2: **2CM=REL**, **1SP=-10.0**, **2DF=3.5**: set point2 = $1SP + 2DF = -6.5$.

5.2. MODE OF OPERATION. Channel 2 may be independent in relation to channel 1 (**2OM=FRE**), or linked to channel 1 (**2OM=BND**). In this last case the values that may be assigned to **2SP** and **2DF** depend on the mode of operation of channel 2, as given in the following examples.

Example 1: channel 1 in heating mode ($1HY < 0$ or $1PB < 0$), channel 2 in cooling mode ($2HY > 0$ or $2PB > 0$); with linked outputs (**2OM=BND**) and set point 2 expressed in the absolute mode (**2CM=ABS**), a control is obtained with **variable neutral zone** by regulating **2SP** between **1SP** and **SPH**. Changing **1SP** changes the amplitude of the neutral zone. E.g.: $1Y=HY$, $1SP=20^{\circ}C$, $1HY=-02^{\circ}C$; $2Y=HY$, $2SP=24^{\circ}C$, $2HY=03^{\circ}C$: channel 1 Off at $+20^{\circ}C$, On at $18^{\circ}C$; channel 2 Off at $24^{\circ}C$, On at $27^{\circ}C$; the minimum value that may be assigned to **2SP** is $20^{\circ}C$ equal to **1SP**. The neutral zone within which both outputs are off is between $20^{\circ}C$ and $24^{\circ}C$ inclusive.

Example 2: channel 1 in heating mode ($1HY < 0$ or $1PB < 0$), channel 2 in cooling mode ($2HY > 0$, or $2PB > 0$); with linked outputs (**2OM=BND**) and set point 2 expressed in the relative mode in relation to set point 1 (**2CM=REL**), a control is obtained with **fixed neutral area** by assigning positive values to **2DF**. Upon changing **1SP** the amplitude of the neutral zone remains constant and is equal to **2DF**. E.g.: $1Y=HY$, $1SP=20^{\circ}C$, $1HY=-02^{\circ}C$, $2Y=HY$, $2DF=4^{\circ}C$, $2HY=03^{\circ}C$: channel 1 Off at $+20^{\circ}C$, On at $18^{\circ}C$; channel 2 Off at $24^{\circ}C (=1SP+2DF)$, On at $27^{\circ}C$. The neutral zone within which both outputs are off is between $20^{\circ}C$ and $24^{\circ}C$ inclusive and has an amplitude of $4^{\circ}C$ equal to the value of **2DF**.

Example 3: channel 1 and channel 2 in heating mode ($1HY < 0$ or $1PB < 0$ and $2HY < 0$ or $2PB < 0$); with linked outputs (**2OM=BND**) and set point 2 expressed in the absolute mode (**2CM=ABS**), a **two-step** control is obtained by regulating **2SP** between **SPL** and **1SP**. Changing **1SP** changes the difference between the two steps. E.g. $1Y=HY$, $1SP=150^{\circ}C$, $1HY=-10^{\circ}C$, $2Y=HY$, $2SP=100^{\circ}C$, $2HY=-5^{\circ}C$: channel 1 Off at $150^{\circ}C$, On at $140^{\circ}C$; channel 2 Off at $100^{\circ}C$, On at $95^{\circ}C$; the maximum value that may be assigned to **2SP** is $150^{\circ}C$ equal to **1SP**.

Example 4: channel 1 and channel 2 in heating mode ($1HY < 0$ or $1PB < 0$ and $2HY < 0$ or $2PB < 0$); with linked outputs (**2OM=BND**) and set point 2 expressed in the relative mode in relation to set point 1 (**2CM=REL**), a **two-step** control is obtained by assigning negative values to **2DF**. Upon changing **1SP** the distance between the two steps remains constant and is equal to **2DF**. E.g. $1Y=HY$, $1SP=150^{\circ}C$, $1HY=-10^{\circ}C$, $2Y=HY$, $2DF=-50^{\circ}C$, $2HY=-5^{\circ}C$: channel 1 Off at $+150^{\circ}C$, On at $140^{\circ}C$; channel 2 Off at $100^{\circ}C (=1SP+2DF)$, On at $95^{\circ}C$.

5.3. TYPE OF CONTROL. Channel 2 can operate in the ON/OFF mode, PID mode or as alarm output: **2Y=HY** is fixed for ON/OFF control, **2Y=PID** for PID control and **2Y=ALR** to set the alarm output.

5.4. ON/OFF CONTROL. In the ON/OFF mode the output is ON or OFF according to the input temperature, differential/set point

(**2SP/2DF**) and the hysteresis value (**2HY**). The hysteresis indicates the amplitude of deviation of the temperature from the set point in order to reactivate the output. Increasing the hysteresis value decreases the switchover of the output, while decreasing the hysteresis value gives finer control. For channel 2 to operate in the heating mode, assign a negative value to **2HY** (see Figure 1); assign a positive value for control in the cooling mode (see Figure 2). With **2HY=0** the output is permanently cut out. After a changeover the output remains in the new state for a minimum time of **2CT** seconds irrespective of the temperature value.

5.5. PID CONTROL. In the PID mode the output is ON for a fraction of the cycle time **2CT**. The cycle time characterises the dynamics of the system to be controlled and influences the accuracy of the control: the higher the system speed of response the shorter the cycle time to obtain greater temperature stability and less sensitivity to variations in load. Assign a negative value to **2PB** to make channel 2 operate in the heating mode and a positive value for control in the cooling mode. With **2PB=0** the output is permanently cut out.

5.5.1. For the characteristics of the proportional (P), proportional-integral (PI), proportional-integral-derivative (PID) control, refer to points 4.3.1. , 4.3.2. , 4.3.3. replacing the parameters related to channel 1 with the corresponding ones for channel 2.

5.6. CHANNEL 2 IN ALARM. A high temperature alarm may be set in this mode by assigning a negative value (see Figure 6) to **2HY** and a low temperature alarm by assigning a positive value (see Figure 7) to **2HY**. The hysteresis indicates the amplitude of the deviation of the temperature from the set point in order to deactivate the alarm. To fix the alarm threshold, see 5.1.

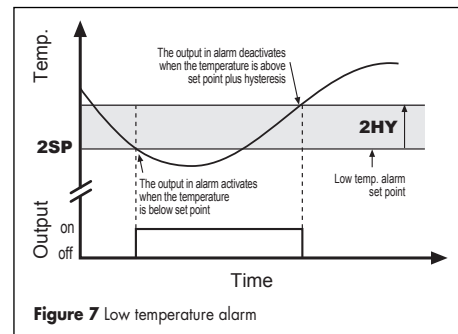
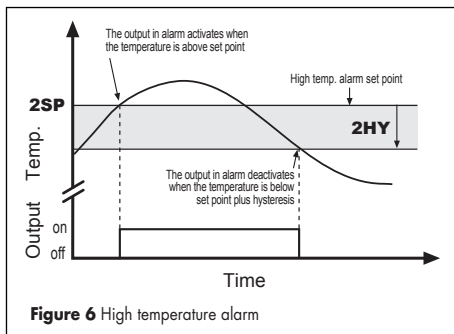













5.7. MALFUNCTIONING. Following a sensor malfunction,  appears on the display and the output is controlled according to the value of the parameter **2PF**.

CAUTION: when programming the hysteresis **2HY** or the proportional band **2PB**, it is advisable to consider the number of switchovers that the relay will carry out and, if necessary, adapt the cycle time in order to limit the frequency of switchover.

6. AUTO-TUNING



6.1. BEFORE STARTING. Before starting the auto-tuning procedure, ensure that the output has been set with PID control, the proportional band has the sign corresponding to the required mode of operation (heating/cooling) and that the set point has been fixed at the required value. The auto-tuning procedure is divided into two parts. In the first part, the operator has to characterise the process to be controlled by fixing the cycle time. In the second, the controller acquires the responses of the system to certain stresses for efficient adaptation of the control parameters.

6.2. STARTING THE FUNCTION. To access the auto-tuning function, keep the keys  +  pressed for 3 seconds. If channel 1 is in the PID mode (1Y=PID), 1CT starts to blink on the display, otherwise 2CT blinks. Using  or , select the cycle time for the channel of which the parameters are to be tuned. Press  to confirm selection of the channel; the current parameter value is displayed simultaneously. Using  +  or , change the cycle time to characterise the dynamics of the process to be controlled. In this first phase the auto-tuning function may be quit by pressing key . The acquisition phase starts upon pressing the keys  +  or after 30 seconds without touching the keyboard.

6.3. ACQUISITION OF RESPONSES. The keyboard is disabled throughout the whole acquisition phase, while  and the measured temperature value appear alternately on the display. If there is a power failure during this phase, the next time the instrument is switched on, after the initial internal self-test phase, it continues the auto-tuning function of the selected channel.

Upon successful completion of auto-tuning, the controller updates the value of the control parameters and starts to control.

6.4. ERRORS. If the auto-tuning procedure is unsuccessful, an indication of the error that has caused the failure blinks on the display:

-  timeout error 1: the controller has not succeeded in bringing the system temperature within the proportional band. Temporarily increase the set point with control in the heating mode and vice versa in the cooling mode, then restart the procedure.
-  timeout error 2: the auto-tuning procedure has not finished within the maximum set time (1000 cycle times). Restart the auto-tuning procedure and set a higher cycle time.
-  temperature over range: after having checked that the error has not been caused by a sensor malfunction, temporarily decrease the set point with control in the heating mode and vice versa in the cooling mode and then restart the procedure.

To erase the error indication and return to the normal mode, press the key .

6.5. CONTROL IMPROVEMENT. If the resulting control is unsatisfactory, proceed as follows:

- to reduce overshoot, decrease the integral action reset **1Ar** (2Ar);

- to increase the response speed of the system, decrease the proportional band **1Pb** (2Pb); caution: doing this makes the system less stable;
- to reduce swings in steady-state temperature, increase the integral action time **1It** (2It); system stability is thus increased, although its response speed is decreased;
- to increase the speed of response to the variations in temperature, increase the derivative action time **1Dt** (2Dt); caution: a high value makes the system sensitive to small variations and may be a source of instability.

CAUTION: during the auto-tuning procedure the temperature oscillates near the set point; it is therefore advisable to remove products to be controlled within severe specifications.

7. RECALIBRATION

If it is necessary to recalibrate the instrument, for example following replacement of a sensor, proceed as follows: have a precision reference thermometer or a calibrator to hand; ensure that the offset **OS1** and the simulation **SIM** are set to 00; select the display scale which is to be recalibrated. Switch the controller off then on again. During the internal self-test phase, press the keys $\square + \square$. With the recalibration function activated, select the value to be changed using \square or \square : **0Ad** allows a calibration of 0, inserting a constant correction over the whole scale of measurement. **SAd** allows a calibration of the top part of the measurement scale with a proportional correction between the calibration point and 0. After having selected the required parameter, press \square to display the value and use $\square + \square$ or \square to make the read value coincide with the value measured by the reference instrument (ensure that the temperature is stable). Exit from calibration by pressing the key \square .

8. SERIAL COMMUNICATION

LTW15 is provided with a serial port for connection with a PC or a programmer. In the first case it is important to assign a different value to the **ADR** parameter for each linked unit (peripheral address); in the case of automatic programming, ADR should remain at 1.

WARRANTY

LAE electronic Srl guarantees its products against defects due to faulty materials or workmanship for one (1) year from the date of manufacture shown on the container. The Company shall only repair or replace products which are shown to be defective to the satisfaction of its own technical services. The Company shall not be under any liability and gives no warranty in the event of defects due to exceptional conditions of use, misuse or tampering. All carriage expenses for returning the product to the manufacturer, after having obtained the latter's permission, and for any return to the buyer shall be paid by the buyer.

WIRING DIAGRAMS

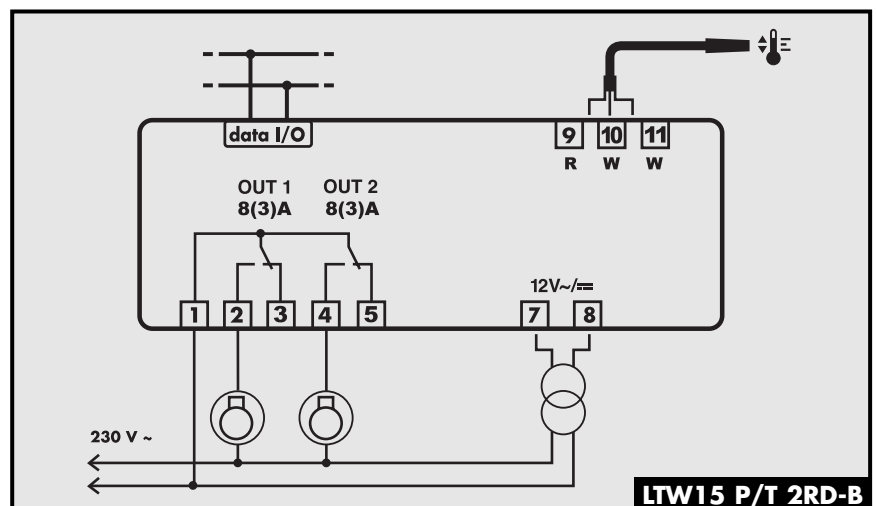

LTW15 P/T 2RD-B

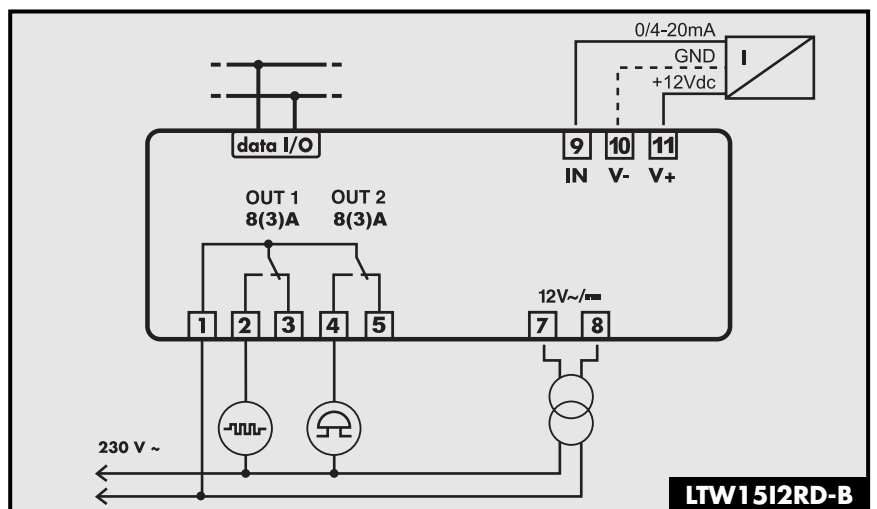
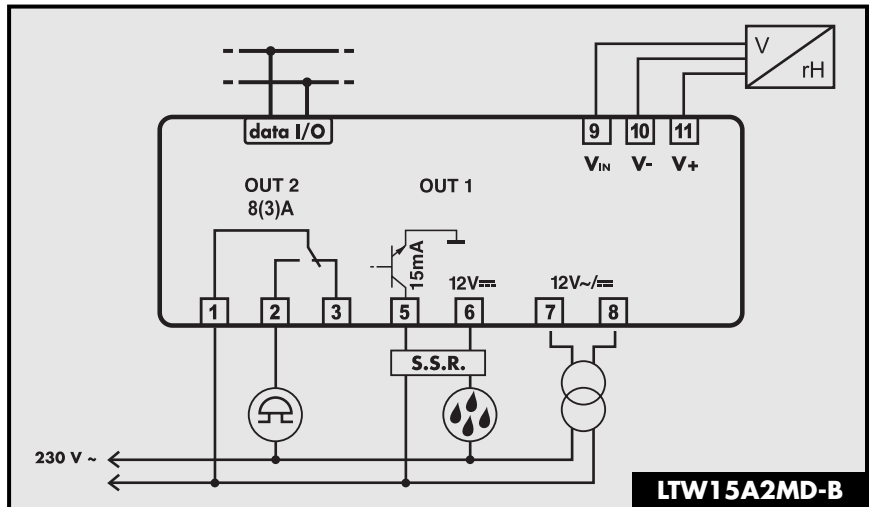
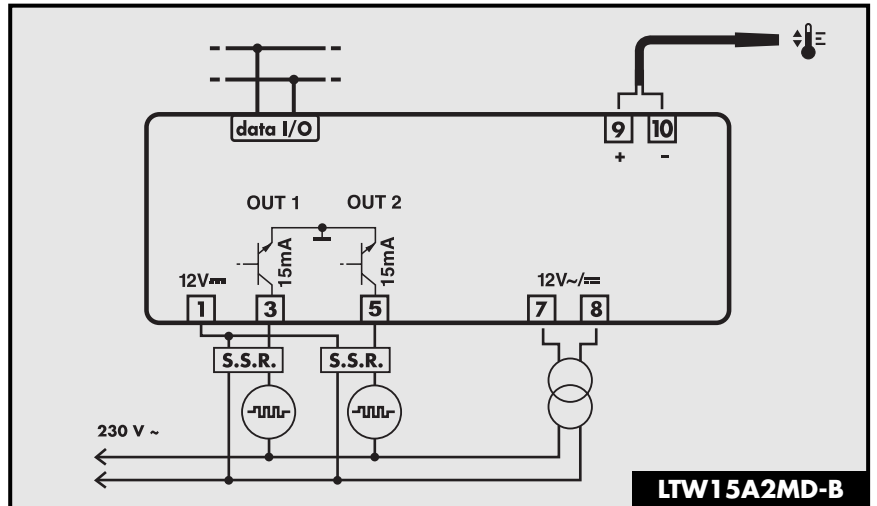

PARTNER VENEZIA • 041 5460713



VIA PADOVA, 25
 31046 ODERZO /TV /ITALY
 TEL. 0422 815320 - 815303
 TELEFAX 0422 814073
 www.lae-electronic.com
 E-mail: info@lae-electronic.com